

MICHIGAN NEW 160

Art.-Nr.

338 772
338 773

↔	1645
↕	750
↗	2052
	mm

1/8
VO

	120 min			PZ2	4	0,5 kg	3m	600 mm

ID	ID			
19272	②	1645*600*16	1x	2/2
19239	③	244*190*16	2x	2/2 1/2
19273	④	1645*120*16	1x	2/2
19241	⑤	2004*194*16	1x	1/2
19242	⑥	2004*194*16	1x	1/2
19258	⑦	2004*244*16	1x	1/2
19274	⑧	1645*396*16	1x	2/2
19244	⑨	244*361*16	2x	1/2
19245	⑩	800*360*16	1x	2/2
19246	⑪	828*242*3	1x	2/2
19247	⑫	598*188*16	1x	2/2
19248	⑬	598*188*16	1x	2/2
19025	⑭	350*120*16	2x	2/2
19249	⑮	528*120*16	2x	2/2
19027	⑯	350*120*16	2x	2/2
19250	⑰	556*356*3	2x	2/2



A

B

21102,00	22232,00	22243,00	22300,00	22430,00	22453,00	22705,00	22707,00
Ø1,6x20	Ø4,0x16	Ø3,5x15	Ø7x50	Ø4x25	M6x25	Ø6,8x8	Ø6,3x11
A 25x	B 4x	C 16x	D 18x	E 4x	F 8x	G 8x	H 16x
22800,01	24091,00	27000,00	30091,00	70013,01	70021,01		31106,00
4	Ø10x11	Ø8x30		Ø15x13			
J 1x	K 8x	L 12x	M 14x	N 16x	P 16x	Q 8x	R 4x
31108,01	32030,00	33006,01	33006,01				
44x23x23	L=150	L=350	L=350				
S 2x	T 2x	U 2x	V 2x				



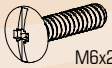

X	✓	X	✓	X	✓	X	X	X	✓

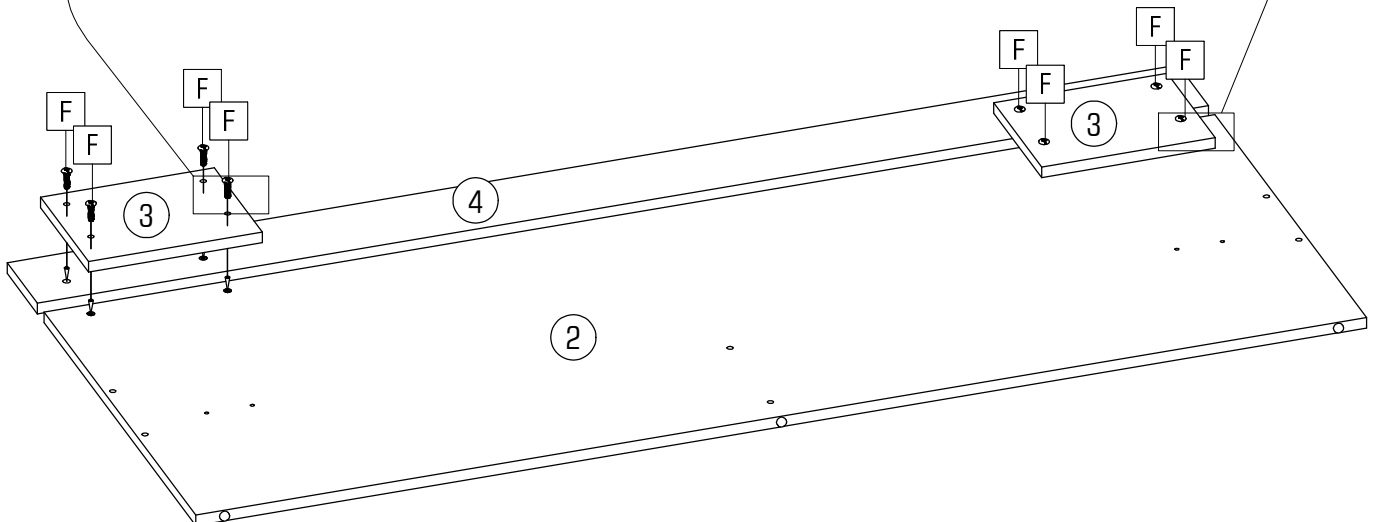
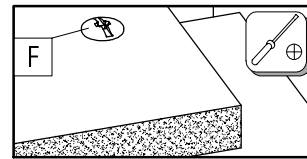
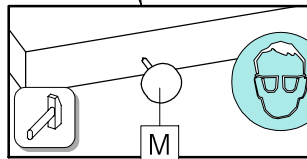
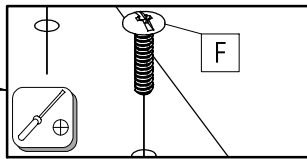
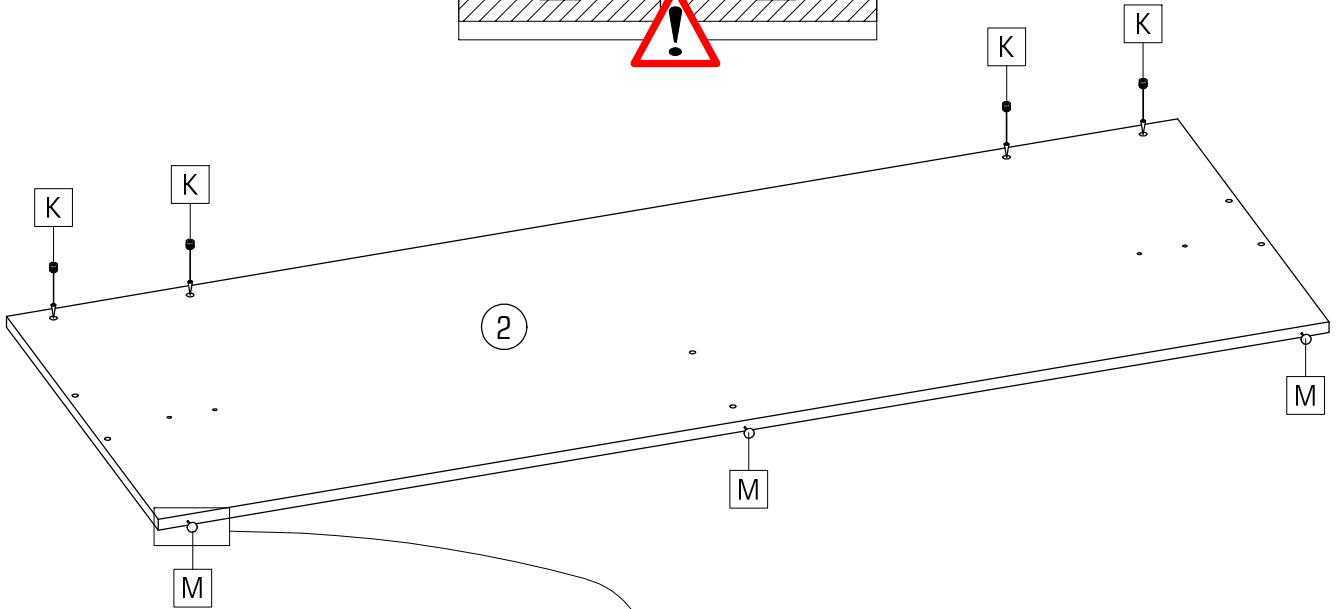
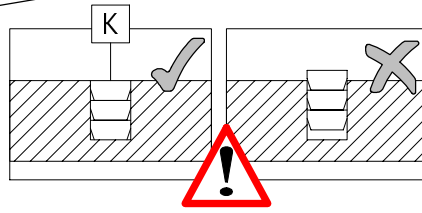
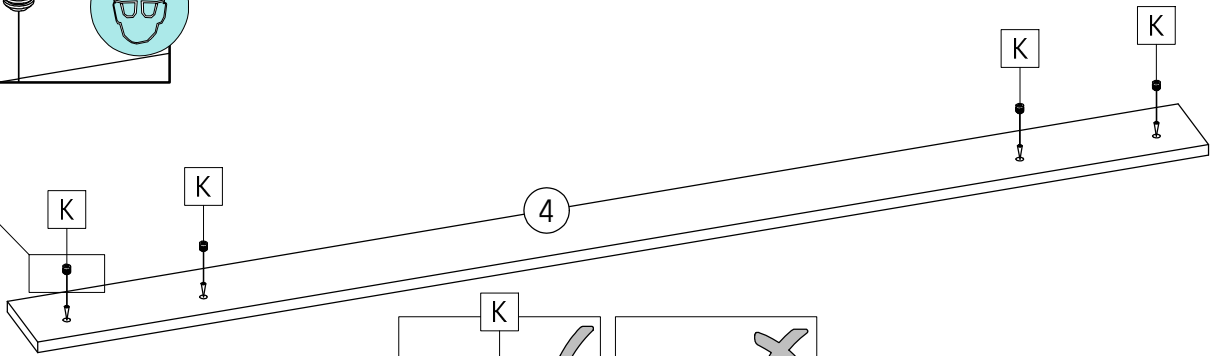
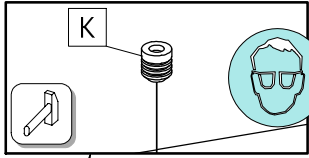
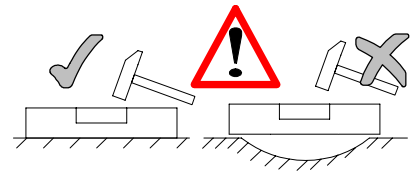
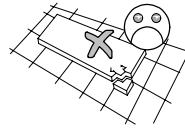
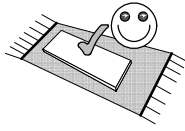
2/8 MICHIGAN NEW 160

		
M6x25	Ø10x11	
F 8x	K 8x	M 3x



MICHIGAN NEW 160 3/8

			
L 12x	M 7x	N 6x	P 6x

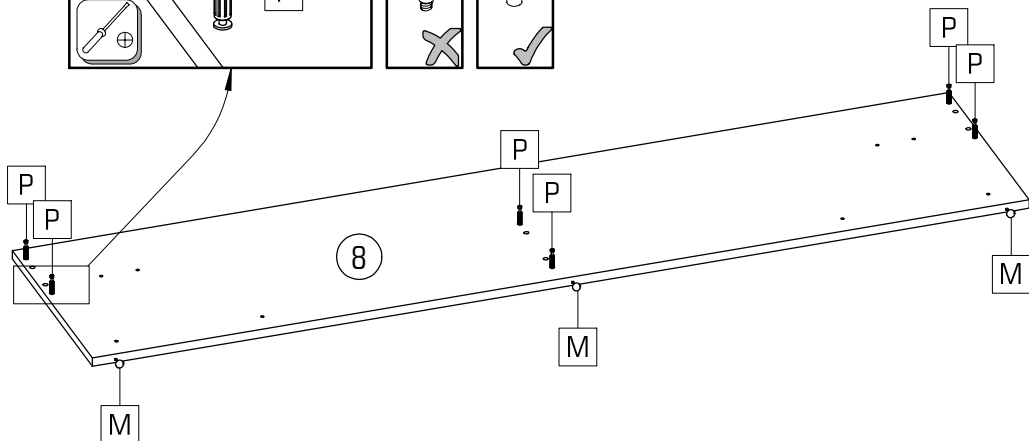
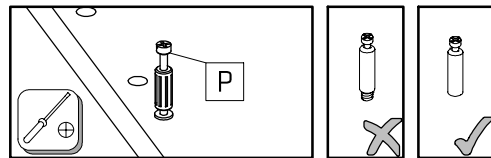
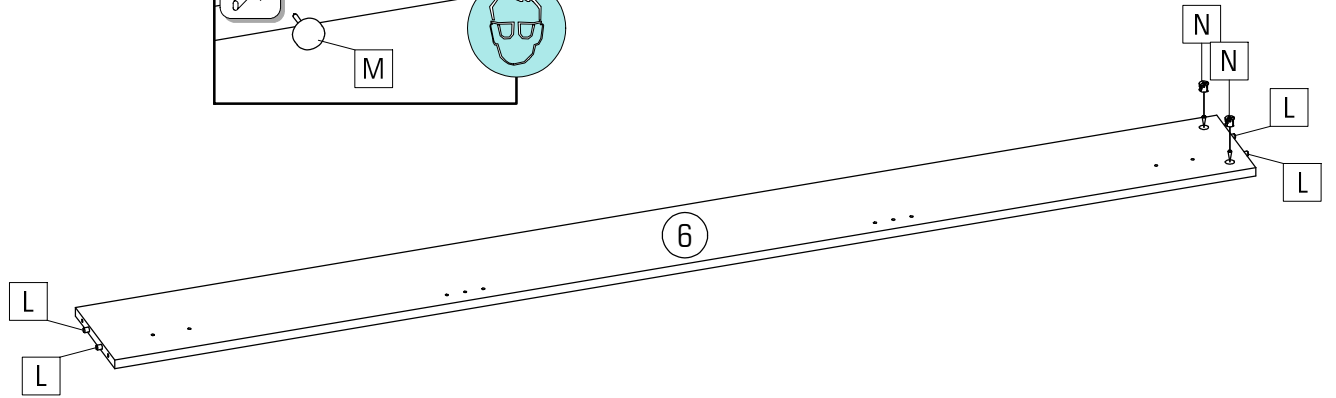
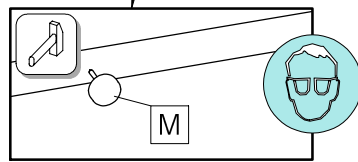
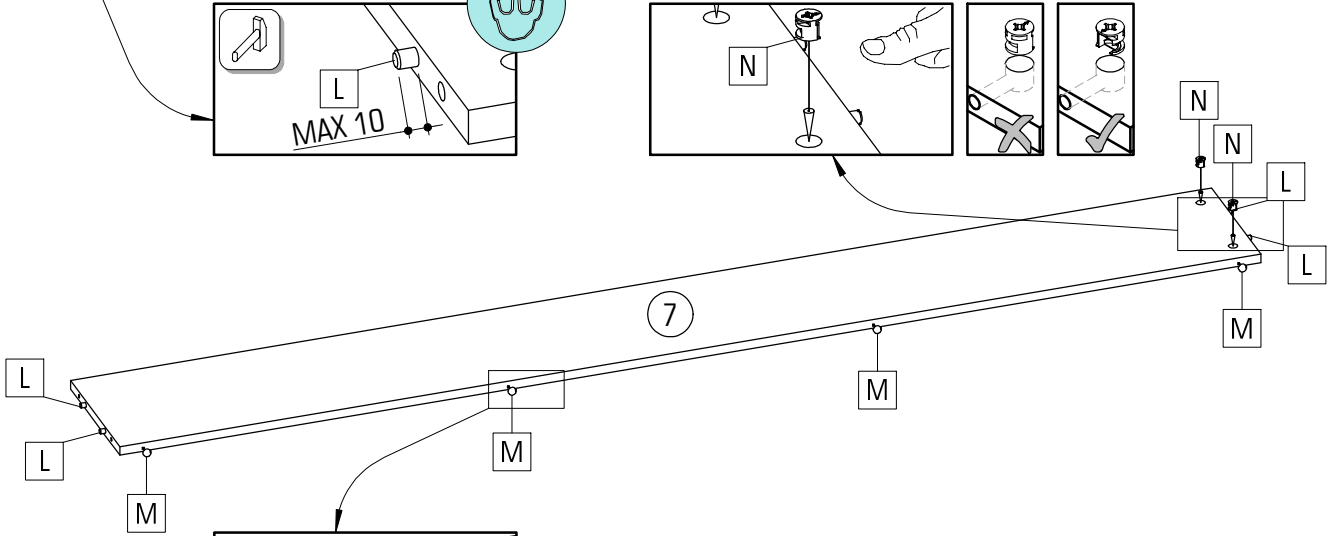
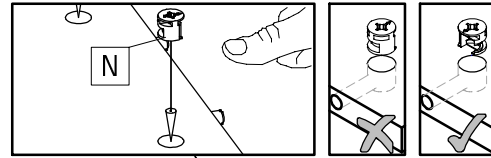
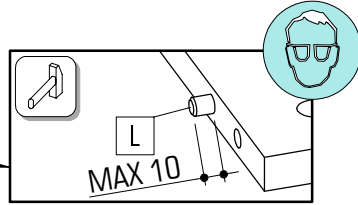
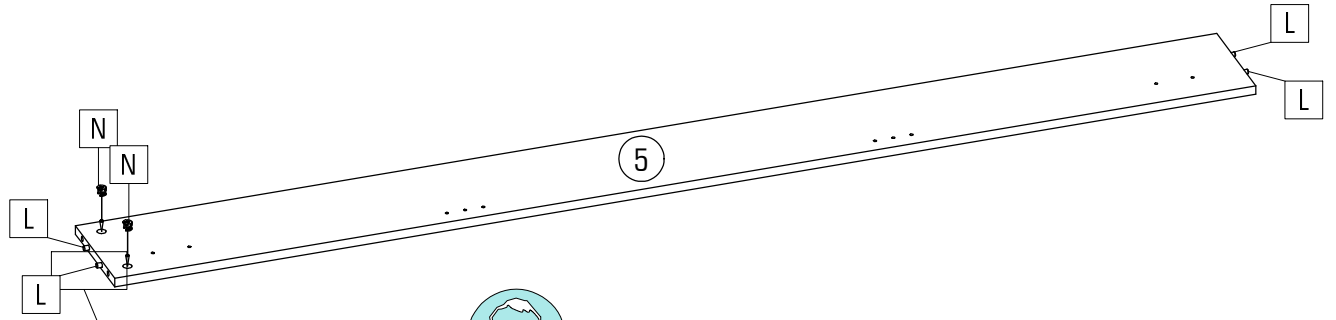
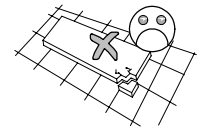
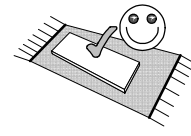

4/8 MICHIGAN NEW 160



Ø7x50

D

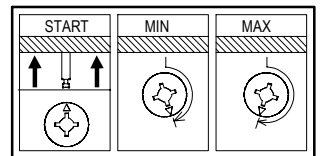
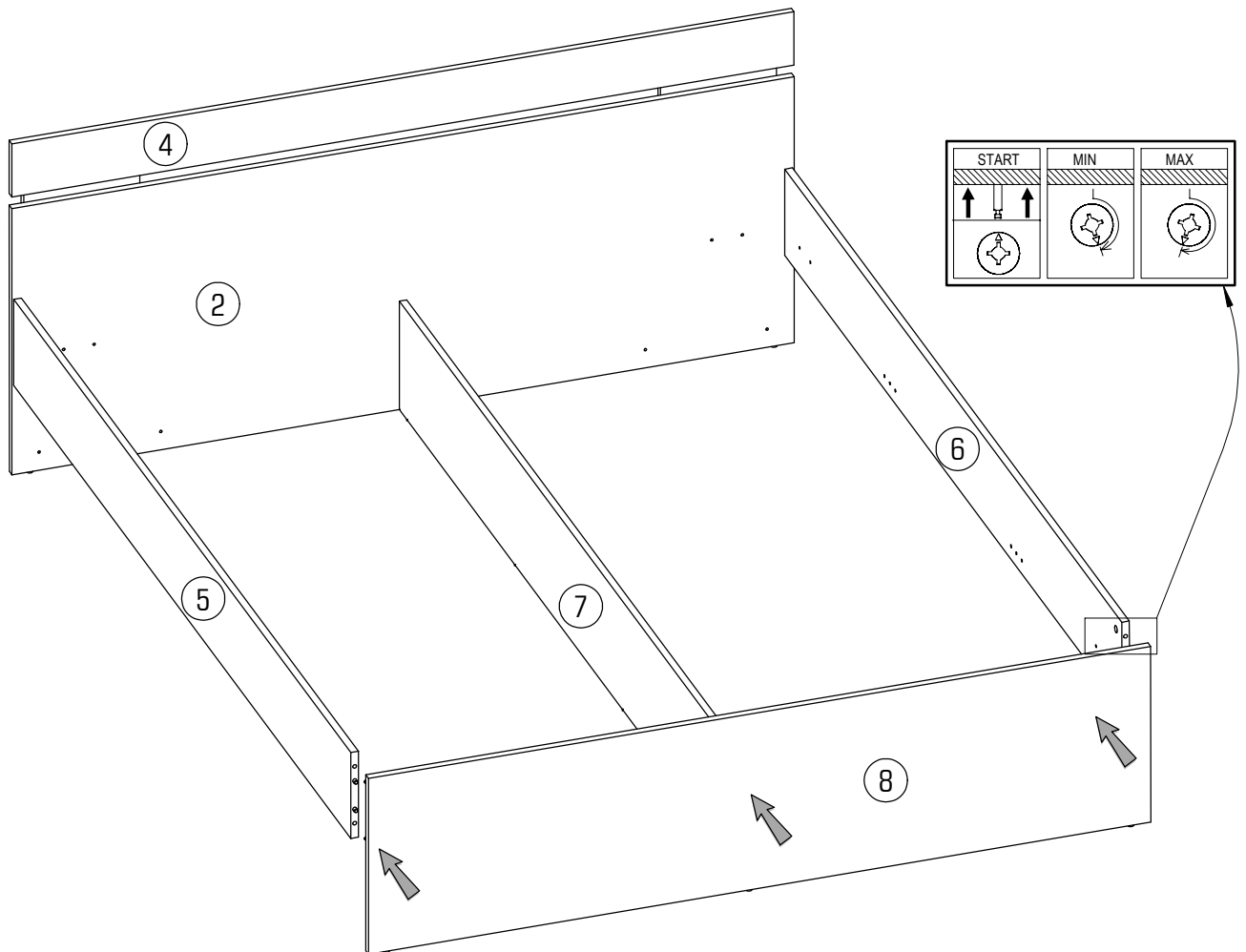
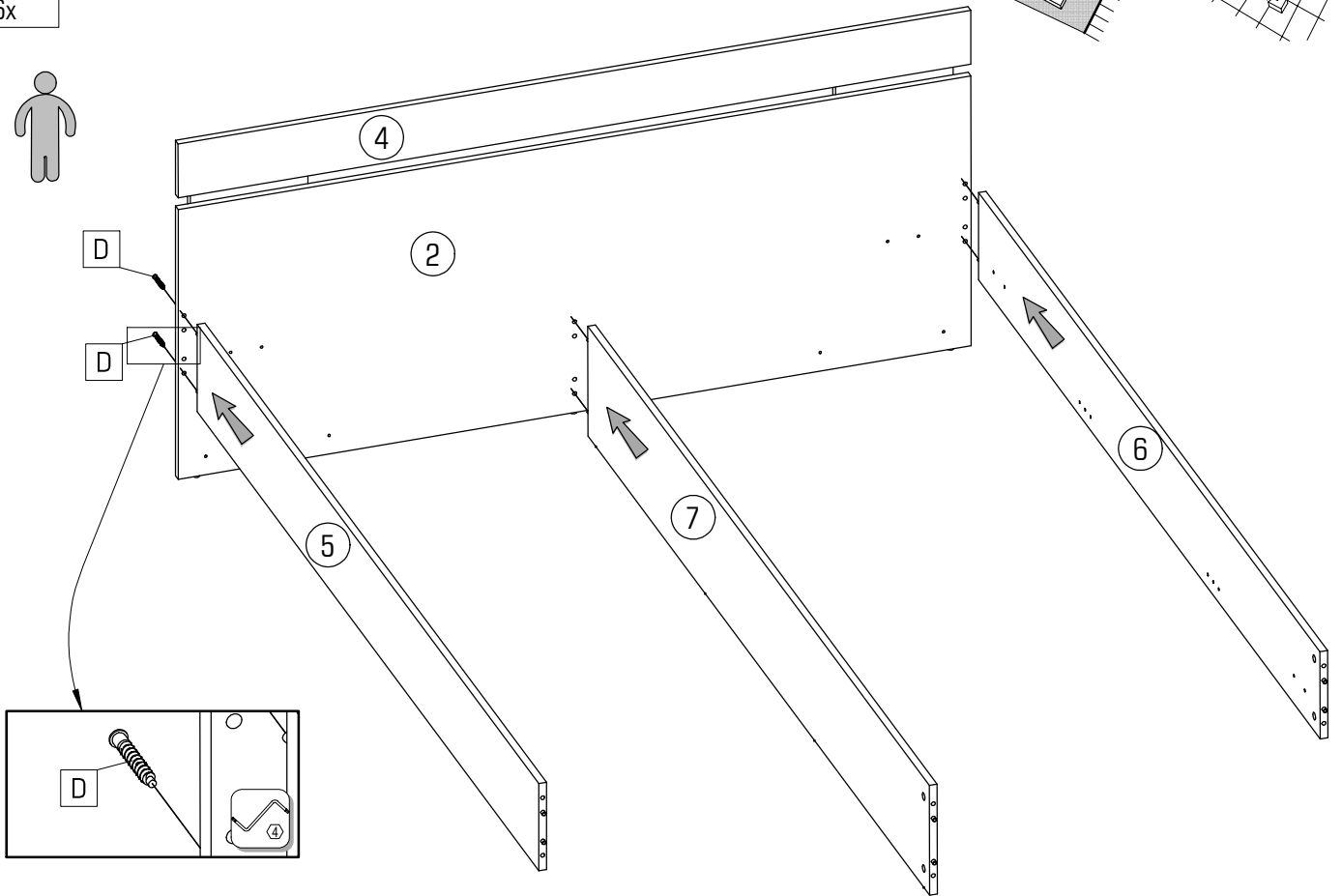
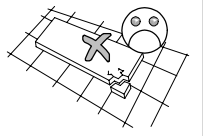
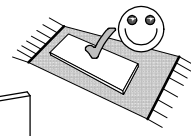
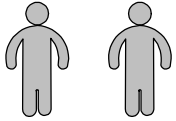

6x



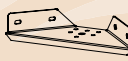

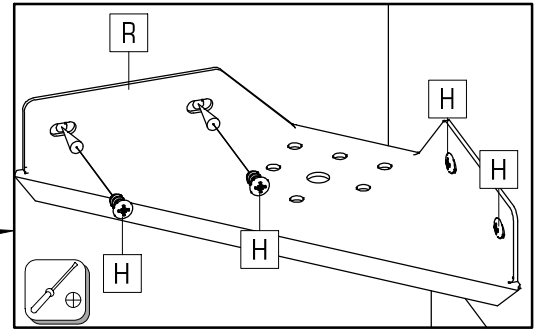
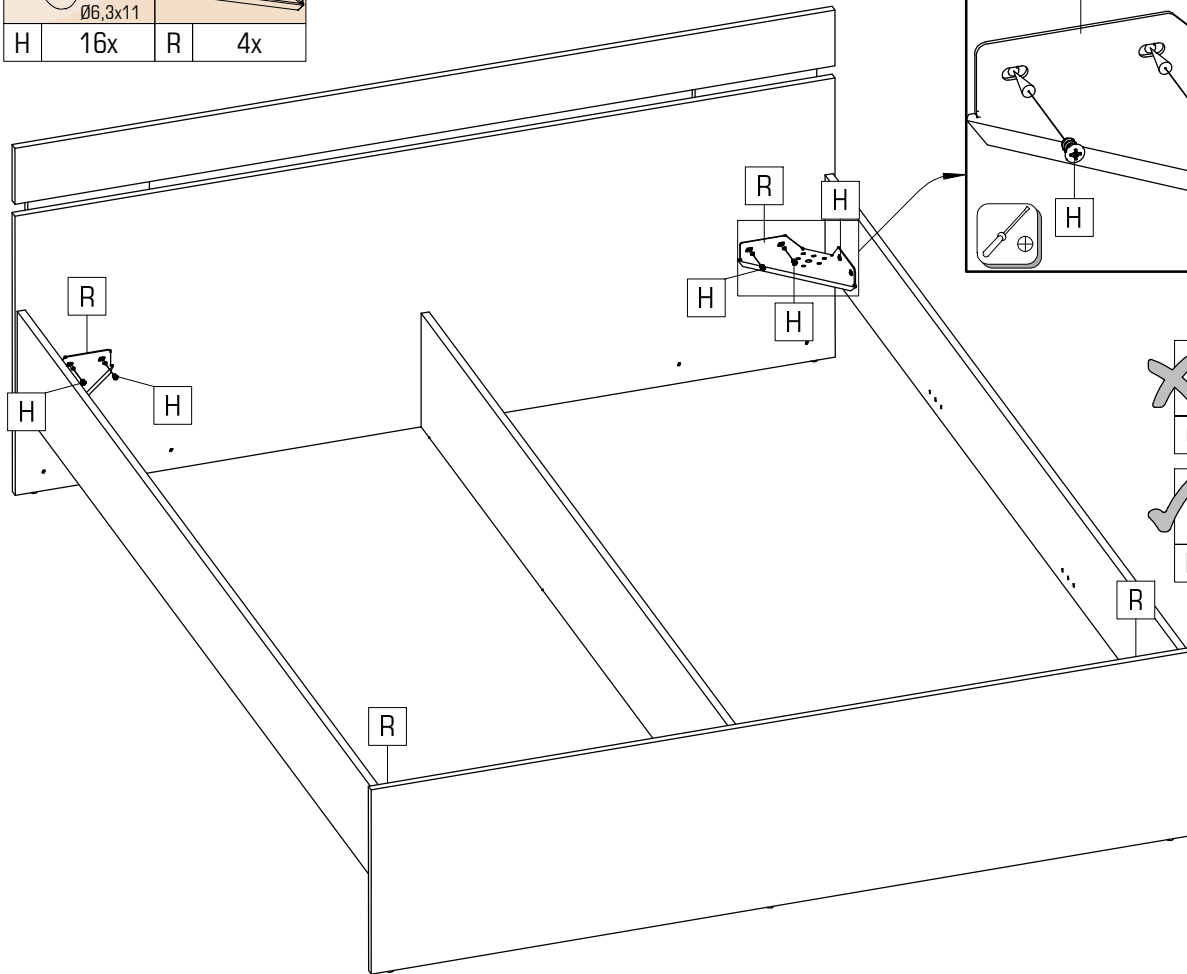

MICHIGAN NEW 160 5/8



	$\varnothing 6,3 \times 11$	
H	16x	R
		4x

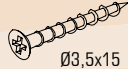

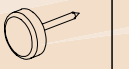
	$\varnothing 6,8 \times 8$	
G	8x	
	$\varnothing 6,3 \times 11$	
H	16x	



	$\varnothing 3,5 \times 15$		$\varnothing 7 \times 50$		$\varnothing 6,8 \times 8$		$\varnothing 15 \times 13$		L=350
C	2x	D	4x	G	4x	M	4x	N	2x
								U	1x



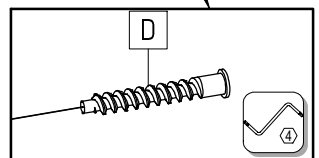
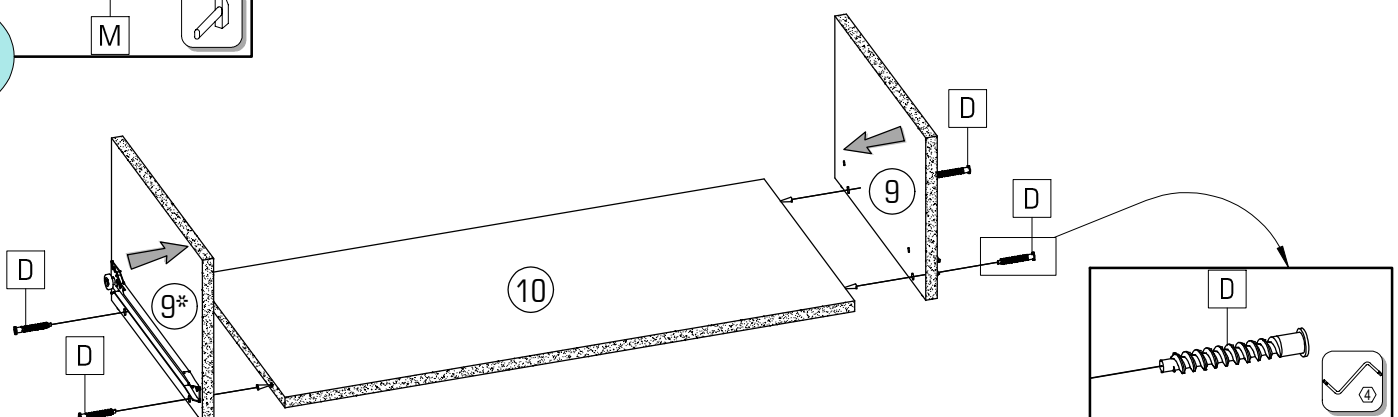
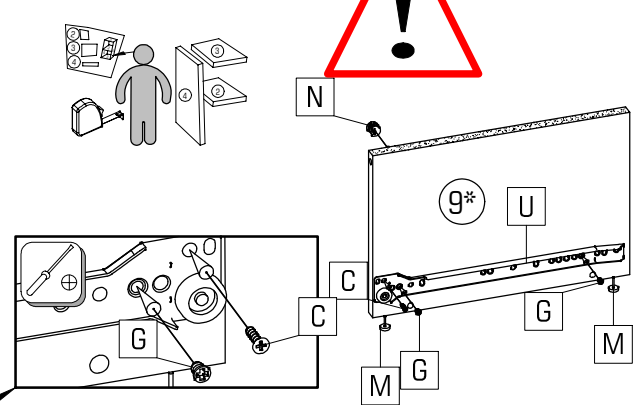
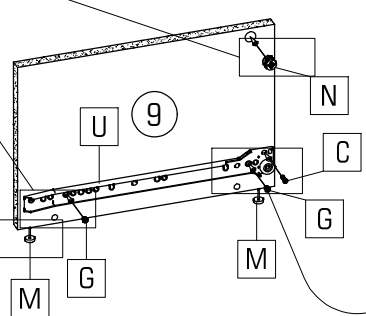
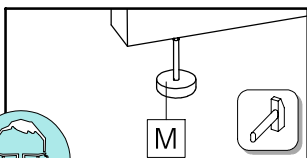
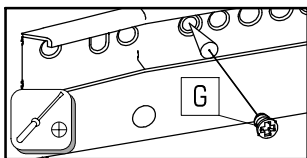
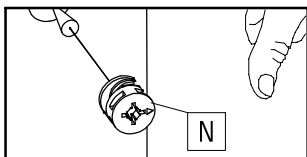



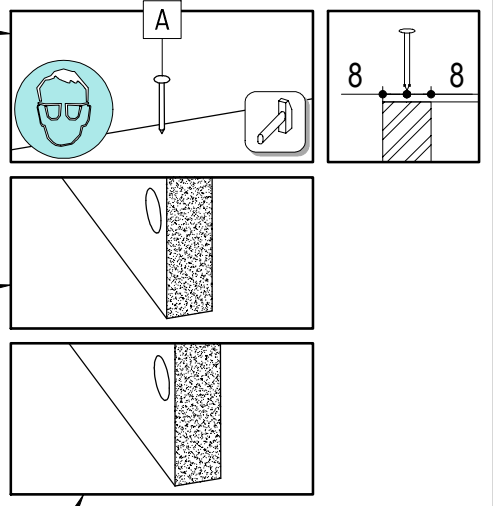
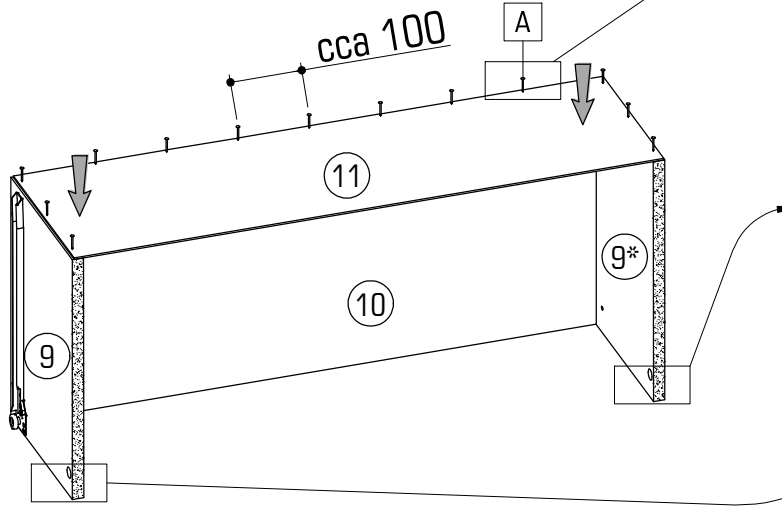

	$\varnothing 6,8 \times 8$		$\varnothing 6,3 \times 11$
G	8x	H	16x

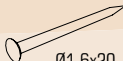
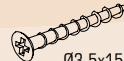

6/8 MICHIGAN NEW 160

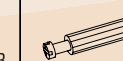



	Ø1,6x20
A	15x

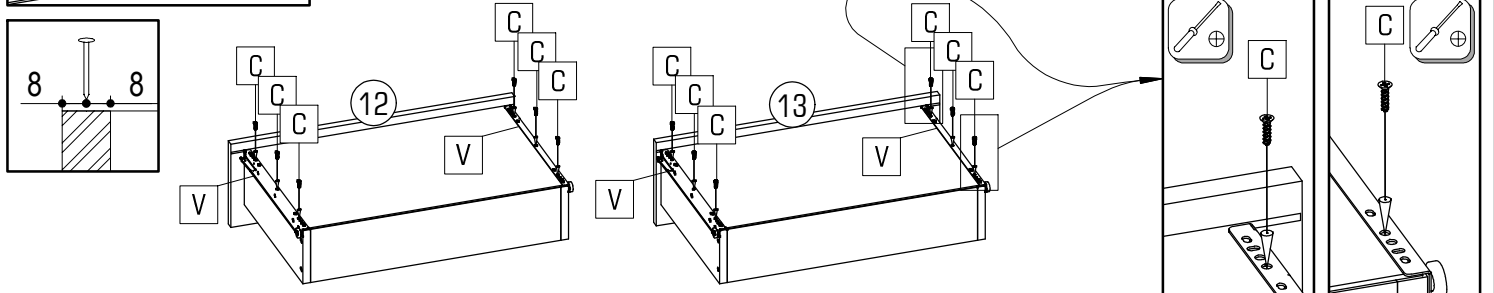
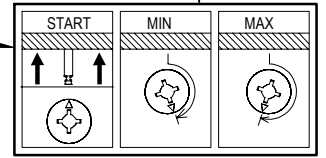
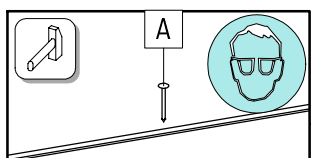
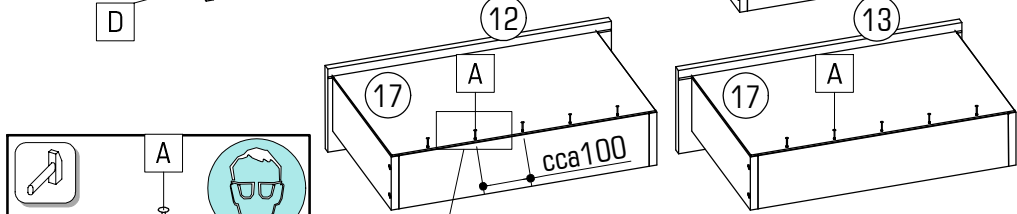
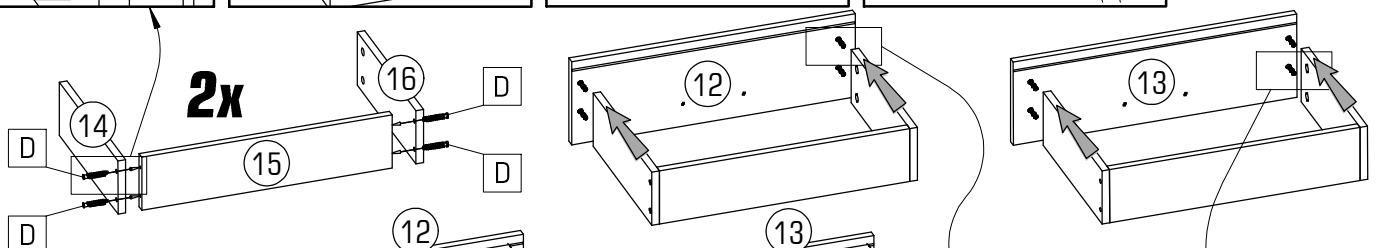
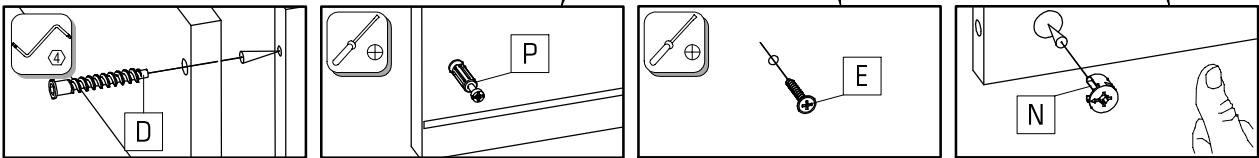
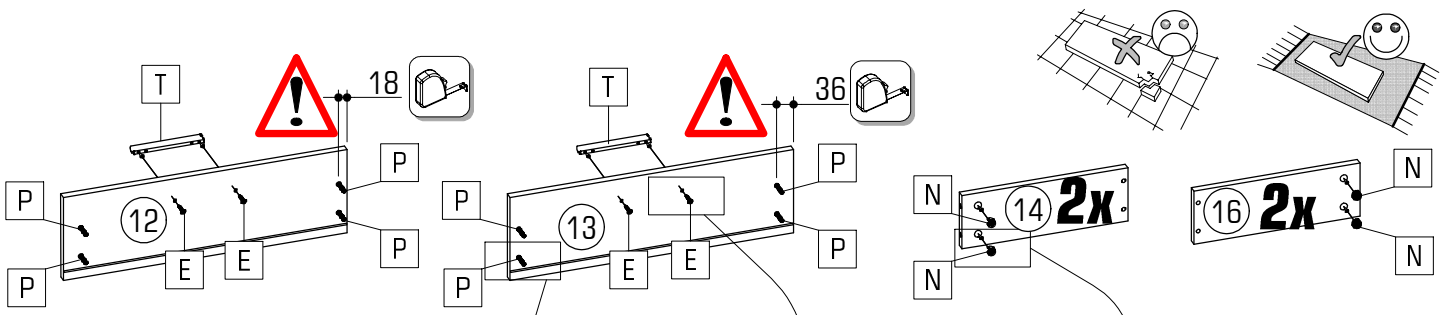

	Ø1,6x20		Ø3,5x15		Ø7x50		Ø4x25		Ø15x13						L=150		L=350
A	10x	C	12x	D	8x	E	4x	N	8x	P	8x	Q	8x	T	2x	V	2x



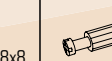

MICHIGAN NEW 160 7/8

					
B	C	G	P	S	U
4x	2x	4x	2x	2x	1x

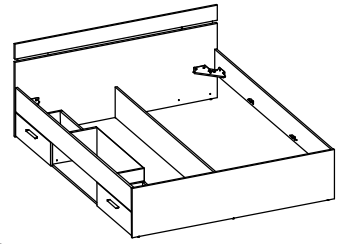



A

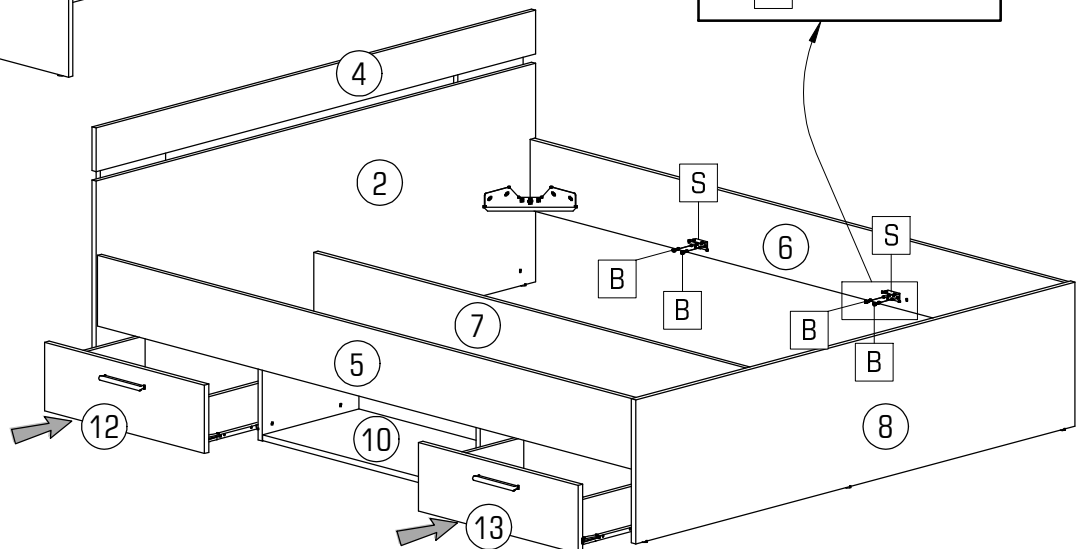
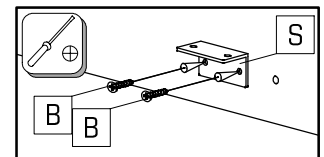
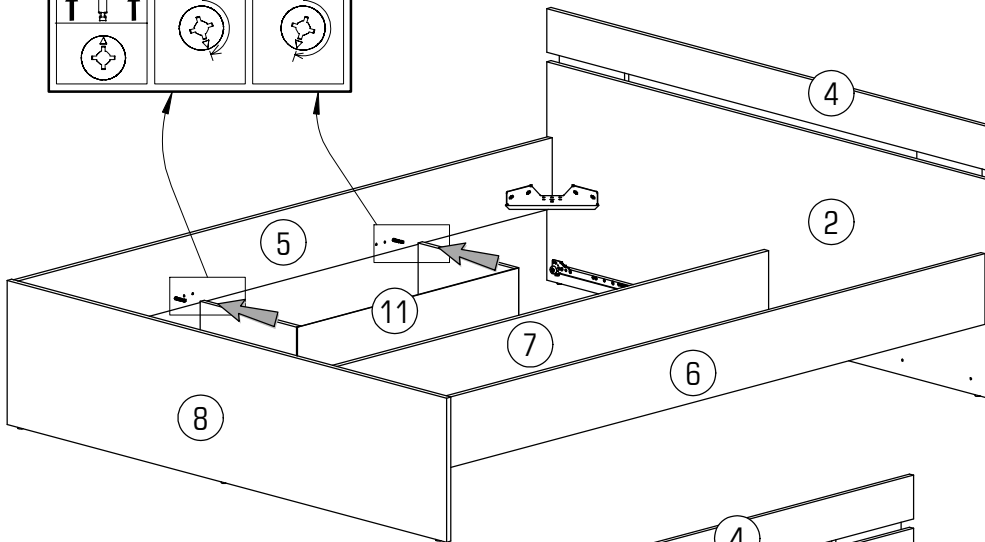
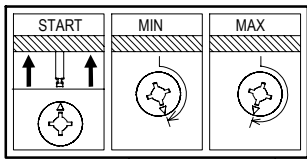
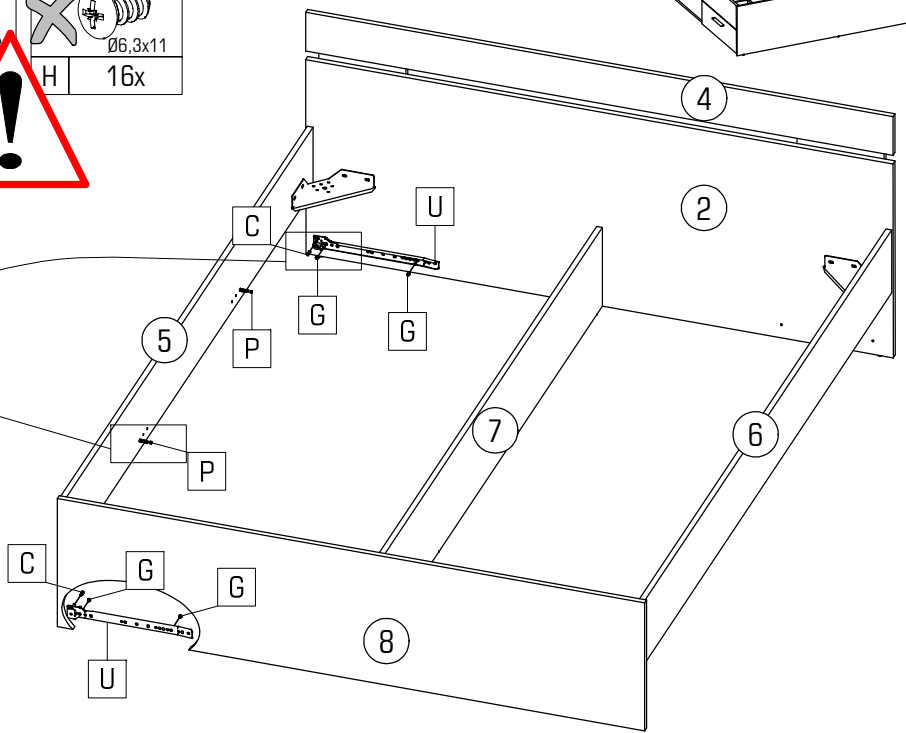
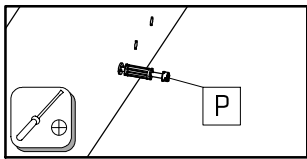
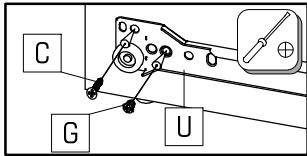

	
G	H
8x	16x

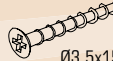

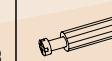
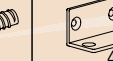

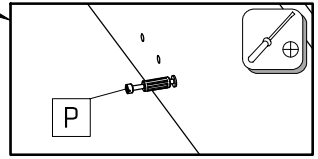
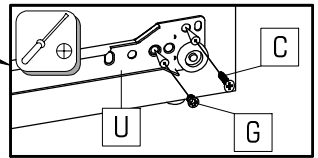
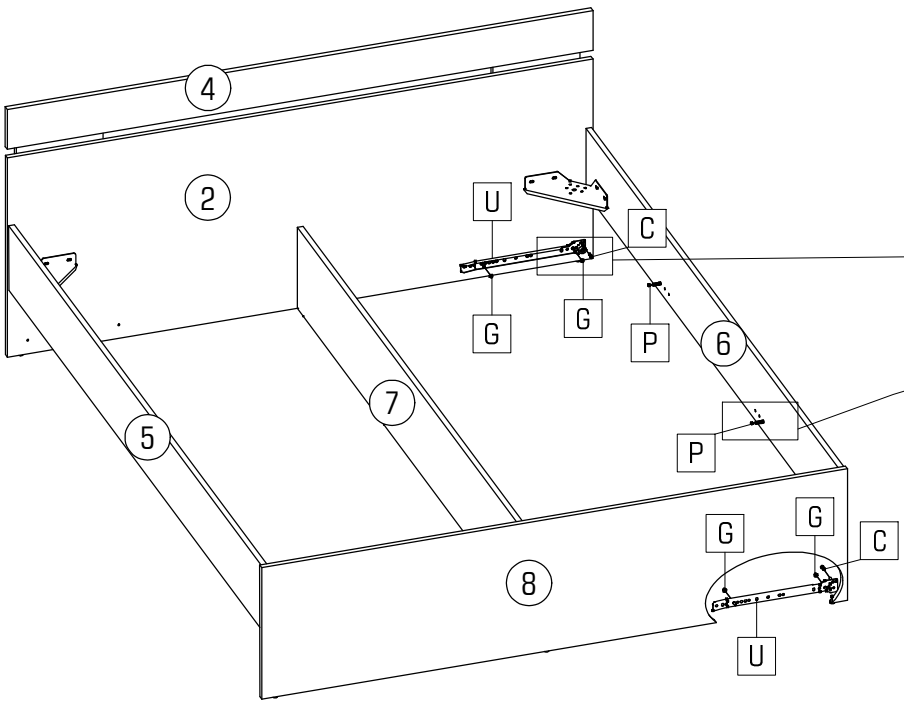
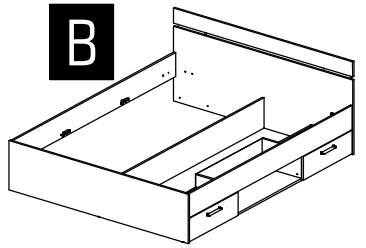

8/8 MICHIGAN NEW 160

					
B 4x	C 2x	G 4x	P 2x	S 2x	U 1x

B



			
G 8x		H 16x	

